

EXCELON® 73
Filter/Regulator
1/4", 3/8", 1/2" Port Sizes

- **EXCELON design allows in-line or modular installation**
- **Quick release bayonet bowl**
- **Highly visible, prismatic liquid level indicator lens**
- **Full flow gauge ports**
- **Balanced valve design minimizes effect of variation in the inlet pressure on the outlet pressure**
- **Modular installations with EXCELON 72, 73, and 74 series can be made to suit particular applications**



Technical Data

Fluid: Compressed air

Maximum pressure:

Transparent bowl: 10 bar (150 psig)

Metal bowl: 17 bar (250 psig)

Operating temperature*:

Transparent bowl: -20° to +50°C (0° to +125°F)

Metal bowl: -20° to +80°C (0° to +175°F)

* Air supply must be dry enough to avoid ice formation at temperatures below +2°C (+35°F).

Particle removal: 5 µm, 25 µm or 40 µm filter element

Air quality: Within ISO 8573-1, Class 3 and Class 5 (particulates)

Typical flow with 10 bar (150 psig) inlet pressure, 6,3 bar (90 psig)

set pressure and 1 bar (15 psig) droop from set:

50 dm³/s (106 scfm)

Manual drain connection: 1/8"

Automatic drain connection: 1/8"

Automatic drain operating conditions (float operated):

Bowl pressure required to close drain: Greater than 0,3 bar (5 psig)

Bowl pressure required to open drain: Less than 0,2 bar (3 psig)

Minimum air flow required to close drain: 0,1 dm³/s (0.2 scfm)

Manual operation: Depress pin inside drain outlet to drain bowl

Nominal bowl size: 0,1 litre (3.5 fluid ounce)

Gauge ports:

1/4 PTF with PTF main ports

Rc1/4 with ISO Rc main ports

Rc1/8 with ISO G main ports

Materials:

Body: Aluminum

Bonnet: Aluminum

Valve: Brass

Bowl:

Transparent: Polycarbonate

Transparent with guard: Polycarbonate, steel guard

Metal: Aluminum

Metal bowl liquid level indicator lens:

Transparent nylon

Element: Sintered polypropylene

Elastomers: Neoprene and nitrile

Ordering Information

See *Ordering Information* on the following pages.

ISO Symbols

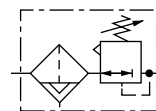

Automatic Drain, Relieving

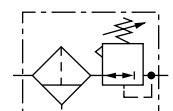

Manual Drain, Relieving

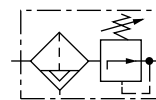

Automatic Drain, Non-Relieving

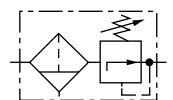

Manual Drain, Non-Relieving



Typical Performance Characteristics

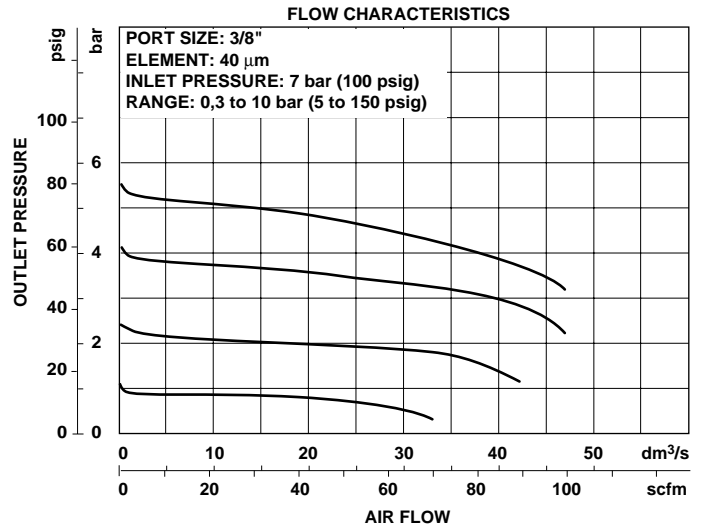
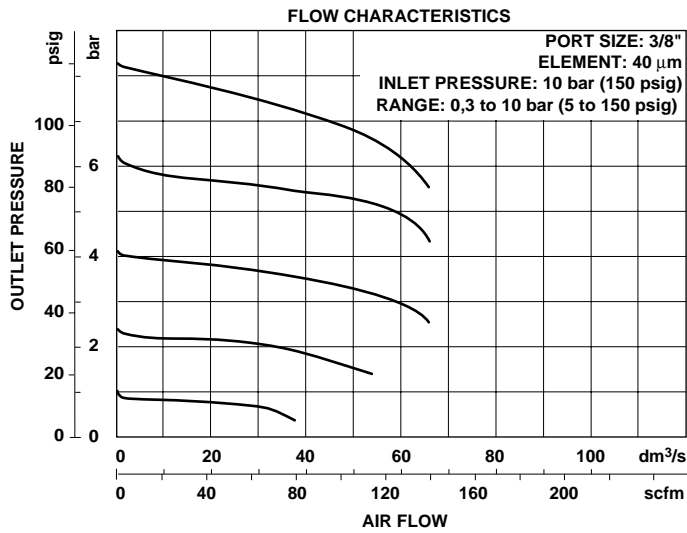

Ordering Information. Models listed include ISO G parallel threads, knob adjustment, automatic drain, metal bowl with liquid level indicator, 40 µm element, relieving diaphragm, and 0,3 to 10 bar (5 to 150 psig) outlet pressure adjustment range*.

Main Port Size	Model Number	Flow† dm³/s (scfm)	Weight kg (lb)
G1/4	B73G-2GK-AD3-RMN	Waiting on lab test	0,7 (1.5)
G3/8	B73G-3GK-AD3-RMN	50 (106)	0,7 (1.5)
G1/2	B73G-4GK-AD3-RMN	50 (106)	0,7 (1.5)

† Typical flow with 10 bar (150 psig) inlet pressure, 6,3 bar (90 psig) set pressure and 1 bar (15 psig) droop from set.

Alternative Models

B 7 3 G - ★ ★ ★ - ★ ★ ★ - ★ ★ ★

Port Size	Substitute
1/4"	2
3/8"	3
1/2"	4
Threads	Substitute
PTF	A
ISO Rc taper	B
ISO G parallel	G
Adjustment	Substitute
Knob	K
T-bar	T
Drain	Substitute
Automatic	A
Manual, 1/4 turn	Q
Bowl	Substitute
Metal with liquid level indicator	D
Transparent with guard	P
Transparent	T



Gauge	Substitute
With	G
Without	N
Outlet Pressure Adjustment Range*	Substitute
0,3 to 4 bar (5 to 60 psig)	F
0,3 to 10 bar (5 to 150 psig)	M
0,7 to 17 bar (10 to 250 psig)	S
Diaphragm	Substitute
Relieving	R
Non relieving	N
Element	Substitute
5 µm	1
25 µm	2
40 µm	3

* Outlet pressure can be adjusted to pressures in excess of, and less than, those specified. Do not use these units to control pressures outside of the specified ranges.

** Units with 17 bar (250 psig) outlet pressure range are available only with the standard metal bowl.

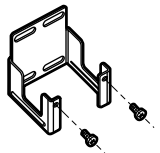
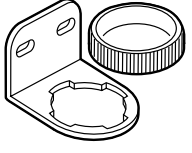
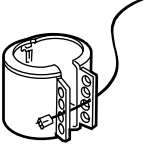

Accessories

				R1/4 Connection	R1/8 Connection	1/4 PTF Connection
Wall Mounting Bracket 4424-50	Neck Mounting Bracket With Zinc Panel Nut Bracket and nut: 4461-50 Nut: 5191-88	Tamper Resistant Cover and Seal Wire†† Cover and wire: 4455-51 Replacement seal wire: 2117-01	Pressure Gauge	4 bar (60 psig): 18-013-266 10 bar (150 psig): 18-013-260 20 bar (300 psig): 18-013-267	18-013-011 18-013-013 18-013-014	18-013-208 18-013-209 18-013-210

†† Use padlock with shackle up to 8 mm (0.3") in diameter.

Dimensions mm (inches)

Panel mounting hole diameter: 48 mm (1.89")
Panel thickness: 2 to 6 mm (0.06" to 0.25")

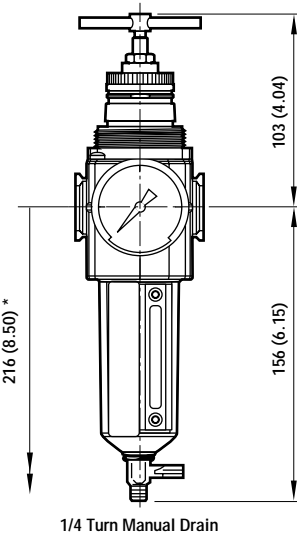
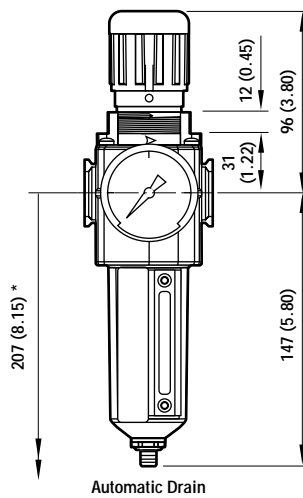
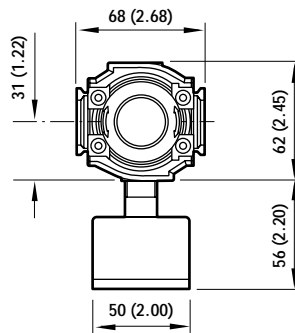

* Minimum clearance to remove bowl.



Bracket Kit Reference

Model	Part No.
All 73 Series products	4424-50
R73, B73 neck mounting bracket with zinc panel nut	5203-06

Bracket Mounting

Universal Wall Bracket for 73 Series Products

Use 6mm (1/4") screws to mount bracket to wall.

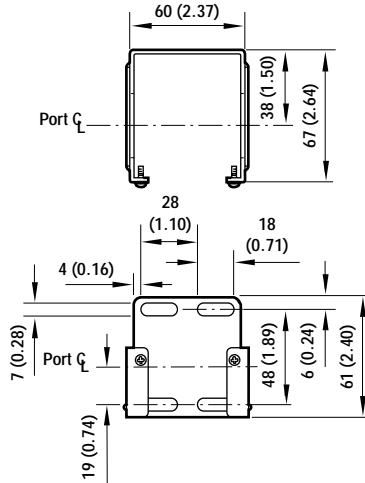

Neck Mounting Bracket for R73 and B73

Includes zinc panel nut. Use 6mm (1/4") screws to mount bracket to wall.

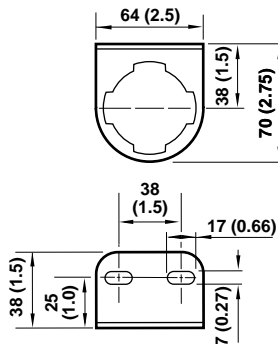

Warning

These products are intended for use in industrial compressed air systems only. Do not use these products where pressures and temperatures can exceed those listed under 'Technical Data'.

Before using these products with fluids other than those specified, for non-industrial applications, life-support systems, or other applications not within published specifications, consult Norgren.

Through misuse, age, or malfunction, components used in fluid power systems can fail in various modes. The system designer is warned to consider the failure modes of all component parts used in fluid power systems and to provide adequate safeguards to prevent personal injury or damage to equipment in the event of such failure.

System designers must provide a warning to end users in the system instructional manual if protection against a failure mode cannot be adequately provided.

System designers and end users are cautioned to review specific warnings found in instruction sheets packed and shipped with these products.

Water vapor will pass through these units and will condense into liquid if air temperature drops in the downstream system. Install an air dryer if water condensation could have a detrimental effect on the application.

Service Kits

Item	Type	Part Number
Service kit	Relieving	4383-600
	Non-relieving	4383-601
Replacement elements	5 µm	4438-01
	25 µm	4438-02
	40 µm	4438-03
Liquid level lens kit	Prismatic	4380-020
Replacement drains	Automatic	4000-51R
	Manual quarter turn	619-50

Service kit includes diaphragm assembly, valve assembly, valve spring, bowl o-ring, and automatic drain seal.